

Product Selection

- ◆ Load Current: 25A, 40A, 60A, 80A
- ◆ SCR Output
- ◆ Control Input: 0-5VDC, 0-10VDC, 4-20mA
- ◆ Phase Angel Control Output or Cycle
- ◆ IP20
- ◆ Built in RC Protection Circuit
- ◆ Panel Mount or 35mm Din Rail Mount
- ◆ Over-temperature Protection
- ◆ SCR Fault Detection Function
- ◆ Load Disconnection Detection Function
- ◆ Phase-lack Detection Function

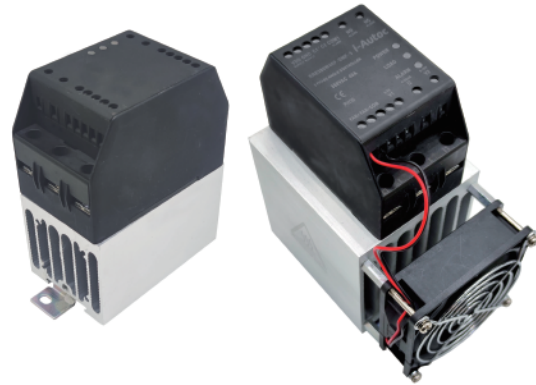

Ordering Information

<b>KRE</b>	<b>600</b>	<b>W</b>	<b>25</b>	<b>P</b>	<b>-D</b>	<b>M</b>	<b>F</b>	<b>-3</b>
KRE Series	Load Voltage 380: 380VAC 600: 600VAC	Control Mode W: 4-20mA 0-5VDC 0-10VDC	Load Current 25: 25Amp 40: 40Amp 60: 60Amp 80: 80Amp	Propotional Output: P: Power C: Cycle	APS D: 24VDC	Characteristic Functions M: Over-temperature Protection (Optional) SCR Fault Detection Function Load Disconnection Detection Function Phase-lack Detection Function EMR Alarm Output	F: 24VDC Fan Blank: No Fan	3: 3 Phase 3 Control 2: 3 Phase 2 Control <sup>(1)</sup>

Note:(1) 3 Phase 2 Control product output type only cycle output.

Selection Guide			
	Control Mode	Load Current	Output Mode
KRE Series	W: 4-20MA 0-5VDC 0-10VDC	25:25Amp 40:40Amp 60:60Amp 80:80Amp	Current Control: $U_{OUT}^2 = U_{ac}^2 \times (ICON-4) / 16$ Voltage Control: $U_{OUT}^2 = U_{ac}^2 \times VCONTROL / 5(10)$

	25A	40A	60A	80A
W:4-20mA 0-5VDC 0-10VDC	KRE380W25P-D-3	KRE380W40P-DF-3	KRE380W60P-DF-3	KRE380W80P-DF-3
	KRE380W25P-DM-3	KRE380W40P-DMF-3	KRE380W60P-DMF-3	KRE380W80P-DMF-3
	KRE600W25P-D-3	KRE600W40P-DF-3	KRE600W60P-DF-3	KRE600W80P-DF-3
	KRE600W25P-DM-3	KRE600W40P-DMF-3	KRE600W60P-DMF-3	KRE600W80P-DMF-3
	KRE380W25C-D-3	KRE380W40C-DF-3	KRE380W60C-DF-3	KRE380W80C-DF-3
	KRE380W25C-DM-3	KRE380W40C-DMF-3	KRE380W60C-DMF-3	KRE380W80C-DMF-3
	KRE600W25C-D-3	KRE600W40C-DF-3	KRE600W60C-DF-3	KRE600W80C-DF-3
	KRE600W25C-DM-3	KRE600W40C-DMF-3	KRE600W60C-DMF-3	KRE600W80C-DMF-3
	KRE380W25C-D-2	KRE380W40C-DF-2	KRE380W60C-DF-2	KRE380W80C-DF-2
	KRE380W25C-DM-2	KRE380W40C-DMF-2	KRE380W60C-DMF-2	KRE380W80C-DMF-2
	KRE600W25C-D-2	KRE600W40C-DF-2	KRE600W60C-DF-2	KRE600W80C-DF-2
	KRE600W25C-DM-2	KRE600W40C-DMF-2	KRE600W60C-DMF-2	KRE600W80C-DMF-2

Technical Specification			
Input Circuit (Ta=25℃)			
Voltage Range of APS			21.6-26.4VDC
Normal working condition	Current of auxiliary source (typical value)	Suffix with F series	≤240mA@24VDC
		Suffix without F series	≤60mA@24VDC
Under fault condition	Current of auxiliary source (typical value)	Suffix with F series	≤50mA@24VDC
		Suffix without F series	≤30mA@24VDC
Control Signal Parameters	Voltage Control	Control Voltage Range	0-5VDC 0-10VDC
		Turn-on Voltage(0-10VDC)	0.4VDC max
		Turn-on Voltage(0-5VDC)	0.2VDC max
		Turn-off Voltage(0-10VDC)	0.1VDC min
		Turn-off Voltage(0-5VDC)	0.05VDC min
		Input Resistance (0-10VDC)	25kΩ Typ.
	Current Control	Input Resistance (0-5VDC)	49kΩ Typ.
		Control Current	4-20mA
		Turn-on Current	4.6mA max
		Turn-off Current	3.8mA min
		Input Resistance	200Ω Typ.

Output Circuit (Ta=25℃)			
Load Voltage Range	380		200-440VAC
	600		400-660VAC
Maximum Surge Current(@10ms)	25A		400A
	40A		500A
	60A		700A
	80A		1280A
Maximun I <sup>2</sup> t(@10ms)	25A		800A <sup>2</sup> s
	40A		1250A <sup>2</sup> s
	60A		2450A <sup>2</sup> s
	80A		8192A <sup>2</sup> s
Transient Overvoltage			1200Vpk <sup>(2)</sup>
Output Power			0-99%
Operating Frequency Range			47-63Hz
Maximum Off-State Leakage Current [@ Rated Voltage]			5mA(@220VAC/50Hz)
Minimum Off-State dv/dt[@ Maximum Rated Voltage]			500V/us

Note:(2) For products with a maximum transient voltage of 1600Vpk, please contact the manufacturer for customization

General Information (Ta=25℃)		
EMR Alarm Node Parameters	Output Type	A set of normally open electromagnetic relays
	Dielectric Withstand (Between Disconnecting Contacts)	1000VAC
	Contact load (Resistance)	2A@250VAC/30VDC
Dielectric Strength, Input/Output/Base[50/60Hz]	Input/Output	4000Vrms
	Input, output/Base	4000Vrms
Ambient Operating Temperature Range		-30℃ ~ +80℃
Ambient Storage Temperature Range		-30℃ ~ +100℃
Weight (typical)	KRE...25... Series	650g
	KRE...(40、60、80)...F Series	1160g
LED Indication	POWER	Power Supply Indicator
	LOAD	Connection Indicator
	ALARM	Fault Indicator

Technical Specification

Function Introduction	
Over-temperature Protection <sup>(3)</sup>	When the product is working, the temperature of the product is monitored in real time. When the set temperature value is exceeded by 100 °C (typical value), the output of the product will be cut off. At the same time, the fault indicator light is on and the output is normally open and the alarm contacts (NO, COM) are closed. It is necessary to wait for the temperature of the product to drop below the set value of 60 °C (typical value) before the product can return to normal working state on its own.
SCR Fault Detection	When no control signal is applied to the product, if the SCR short circuit is found, the product will cut off the output, at the same time, the fault indicator light is on and the output is normally open and the alarm contact (NO, COM) is closed.
Load Disconnection Detection	When no control signal is applied to the product, if load disconnection is found, SSR output will be cut off. At the same time, the fault indicator will be lighted and the output of the alarm contacts (NO, COM) will be closed.
Phase-lack Detection	When the phase-lack failure happens in 3 phase voltage, the relay will automatically cut off the output with the fault indicator lighted and the output of the alarm contacts (NO, COM) will be closed.

Note: (3) if you need to change the threshold value of overtemperature protection temperature setting and recovery temperature setting in the overtemperature protection function, you can contact the manufacturer to customize.

Outline Dimensions

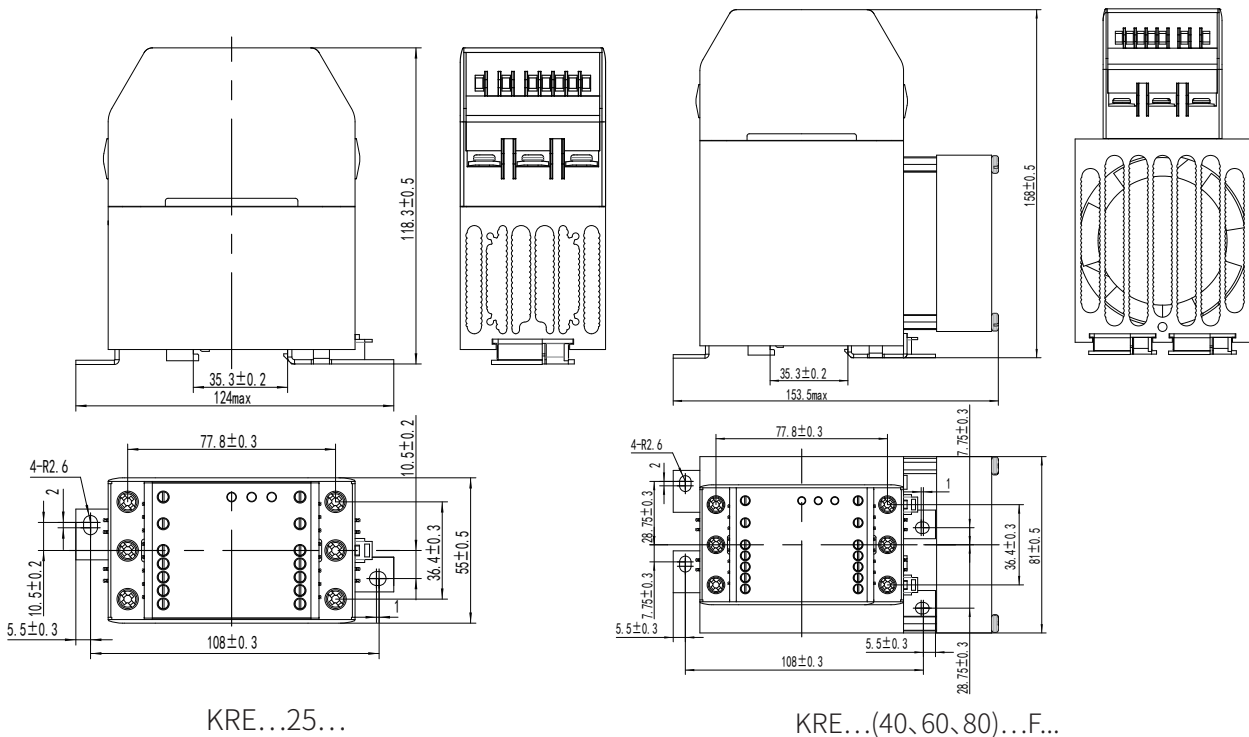

KRE...25...

KRE...(40, 60, 80)...F...

Outline Dimensions

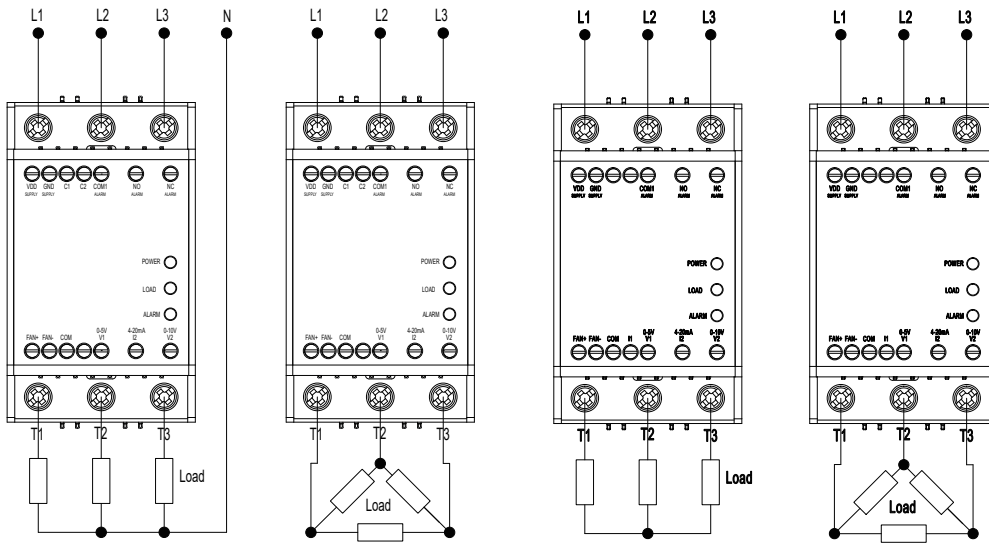

KRE...-3

KRE...-2

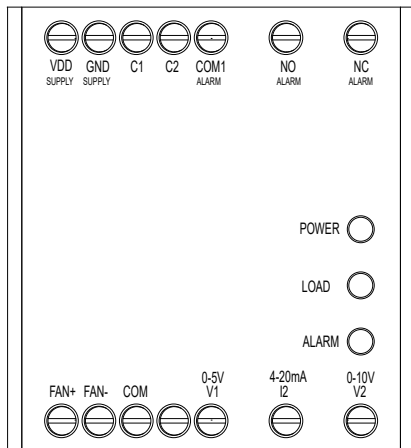

GND, COM: GND and COM are connected together as public negative end;

VDD: The positive pole of auxiliary power supply;

V1: The positive pole of 0-5VDC voltage control input;

V2: The positive pole of 0-10VDC voltage control input;

I2: The positive pole of 4-20mA current control input;

C1, C2: Load type selection --- if C1, C2 suspension then the load does not connect with zero line; if C1, C2 is short connection, then the load connects with zero line;

Power LED (POWER, RED): LED is lighted when with APS;

Connection LED (LOAD, GREEN): LED is lighted when the load has an output;

Fault LED (ALARM, RED): LED is lighted when SSR has a failure;

FAN+: 24VDC DC FAN positive pole;

FAN-: 24VDC DC FAN negative pole;

NC: EMR output normally closed alarm contacts;

NO: EMR output normally open alarm contacts.

COM1: EMR output common end.

Thermal Derating Curve

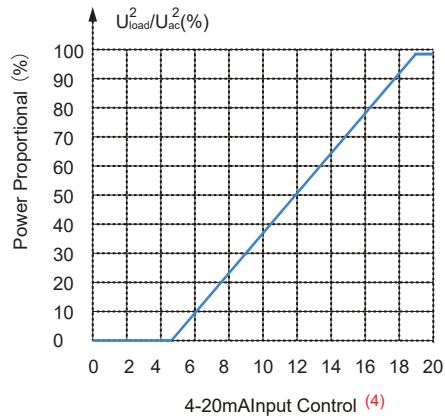
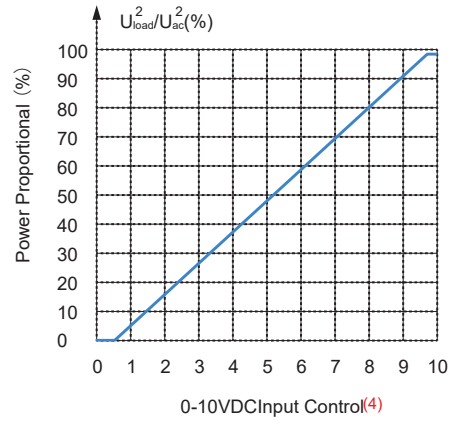
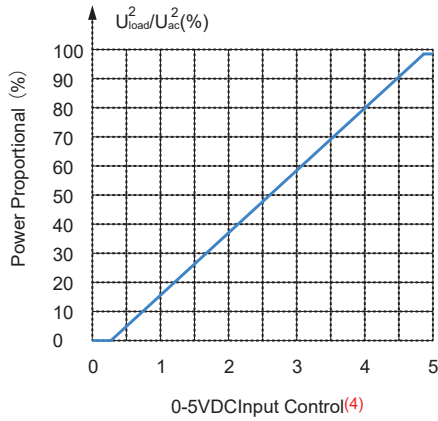

Note: (4) The output curves are measured at 50Hz.

Thermal Derating Curve

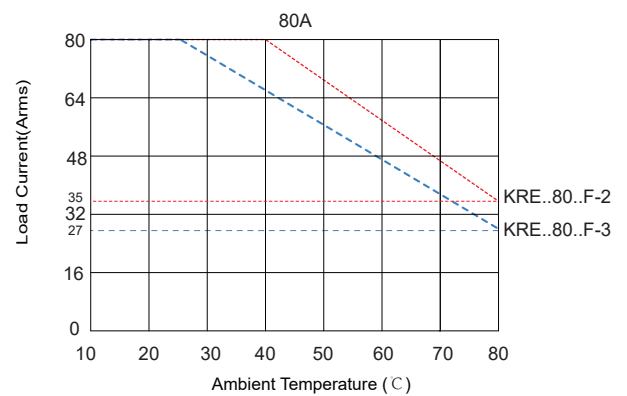
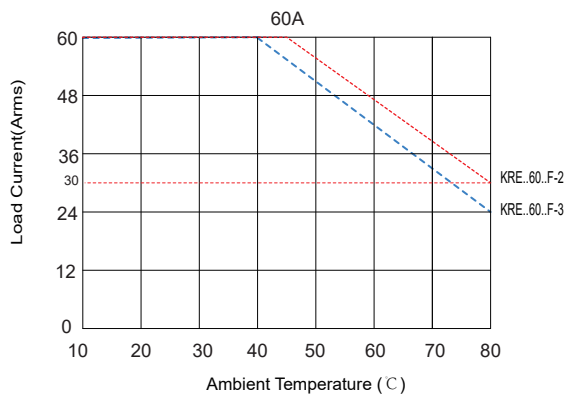
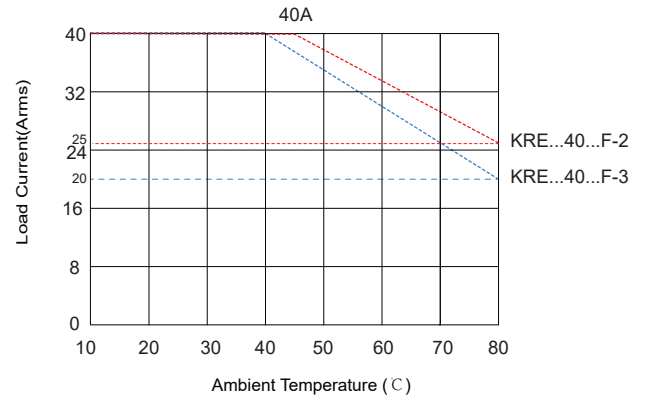
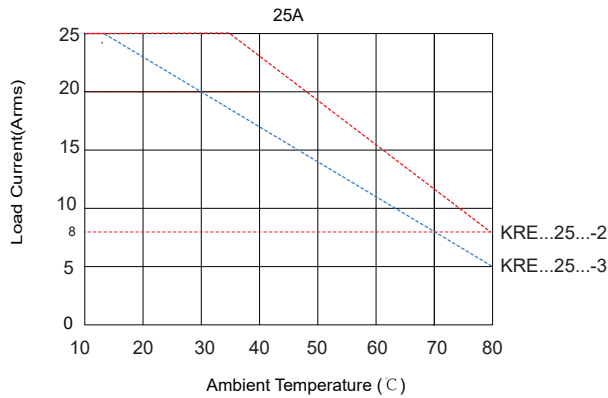

### Important Notice

1. When the operation temperature is high, please consider the derating as per the thermal curve.
2. The relay terminal should ensure reliable connection; poor connection may lead to the product overheating and damaging the product;
3. Input torque is recommended as (0.35-0.45) N·m while output M4 terminal torque is recommended as (0.98-1.37) N·m.
4. This product has a built-in fault detection circuit, so the L1, L2, L3 of the product must be connected with the phase line. T1, T2, T3 can work normally, and the phase line is inverted with the load.
5. Ensure the electrical grounding reliably during the use of the SSR.

### ! Warnings

1. The product's side panels may be hot, allow the product to cool before touching.
2. Disconnect all power before installing or working with this equipment.
3. Verify all connections and replace all covers before turning on power.